

PLG
Reference & Maintenance Manual



**32114 Mallard Ave.
PO Box 409
Tangent, OR 97389-0409
U.S.A.**

Phone: [541] 791-9678
Fax: [541] 791-9410
Toll Free: [888] 754-3111
Web: www.primatics.com
E-mail: info@primatics.com

PLG110, PLG160 & PLG210 Manual Revision Information

Revision Date	Notes
Oct 2003	
March 2003	Changed recommended grease from Lithium #2 to NSK Clean room grease
April 2005	Updated formatting & content
June 2006	Added table 7-2
November 2006	Updated PLG options images
January 2007	Updated Ordering Info
January 2008	Deleted P4 option
September 2014	Deleted model configurations
Jan 2015	New Logo

Notice: The descriptions, drawings, and specifications contained herein are subject to change. Primatics is not responsible for errors or omissions herein or for incidental damages in connection with the furnishing or use of this information. This document shall not be reproduced, photocopied, or duplicated, in whole or in part, without prior written approval of Primatics Corporation.

For Specifications, Dimensioned Drawings and additional information, refer to the PLG Datasheet available from our website at www.primatics.com.

©Copyright 2008-2015 by Primatics, Inc; All Rights Reserved. Primatics, the Primatics logo, PrimaFlex, PrimaSeal & SimpleMatch are trademarks of Primatics, Inc.

PLG110, PLG160 & PLG210 Manual Revision Information2

2) Introduction – About the PLG Family5

3) Models5

4) Personal Safety.....6

5) Conventions7

 5.1) Direction of Motion 7

 5.2) Units of Measure 7

6) Installation Preparations8

 6.1) Linear Motors 8

 6.2) Heat and Humidity..... 9

 6.3) Contamination 9

 6.4) Electrical Noise 10

 6.5) Using the PLG in a Class 10 Cleanroom 10

 6.6) Using the PLG in a Vacuum..... 10

7) Installing the PLG Positioning Stage..... 11

 7.1) Tools you will need..... 11

 7.2) Unpacking 11

 7.3) Installing Motors on Ballscrew Stages 12

 7.3.1) In-Line Motor Mounting 12

 7.3.2) Parallel motor mounting 13

 7.4) Mounting surface preparation 16

 7.5) Mounting the Stage 16

 7.6) Electrical Connections..... 17

 7.6.1) Color Codes for Pigtailed Cable..... 22

 7.6.2) Hall Effect Commutation Sequence 23

 7.7) Home and Limit Sensors..... 23

 7.7.1) Home Options: 24

 7.8) Limit and Home Switch Adjustment 25

 7.9) Recommended System Test..... 26

8) Preventive Maintenance27

 8.1) Lubrication..... 27

 8.2) Protection Belts 27

 8.2.1) Replacing Belts at the End Opposite of the Cable Exit..... 28

 8.2.2) Replacing Belts at the End of the Cable Exit 30

9) Troubleshooting & Service31

 9.1) Troubleshooting FAQ's 31

 9.2) Troubleshooting Help 34

 9.3) Service 34

1) Overview

This user guide is designed to help you install and maintain your PLG Series linear positioning stage application. Follow these steps to ensure correct stage installation and maximum stage life:

- Step 1* Review this entire user manual. Become familiar with all installation procedures prior to integrating your system.
- Step 2* Review the safety summary to develop an understanding of standard safety practices when installing and operating automated equipment.
- Step 3* Familiarize yourself with the conventions summary.
- Step 4* Review installation procedures. For best results, follow these procedures carefully.
- Step 5* Once you successfully complete all the installation procedures, you will be ready to install and operate your stage.
- Step 6* Review preventive maintenance section for proper lubrication schedule.

2) Introduction – About the PLG Family

Each Primatics PLG positioning stage is designed for precision movement in one axis. The individual PLG stage can be ordered in a variety of configurations, from the differing cross-sectional sizes and lengths to the numerous motor options to the various protection levels. The stages can be stacked to make X-Y or X-Y-Z systems.

There are three model Series in the PLG Family: PLG110, PLG160 & PLG210. Each is briefly described in the table below.

	PLG110	PLG160	PLG210
Basic Width x Height (mm)	110 x 60	160 x 80	210 x 90
Travel Lengths (mm)	50 to 600	50 to 800	100 to 1200
Drive Types	Linear Motor or Ballscrew		
Encoder Option	Rotary or Linear		
Payload (kg)	25	50	100

Each can be configured with options listed in Section 3.

Many customers choose the Primatics Motion Drive Chassis (MDC) to power PLG stages. The MDC is a modular system that packages motor drivers, encoder interfaces, power supplies and safety systems into a single chassis. It acts as an intermediary between a Galil Optima, National Instruments 7344 or Delta Tau PMAC II motion control cards and a Primatics positioning stage. Pre-wired high-flex cables are available to allow a convenient connection from the stage to the MDC chassis. The MDC drive chassis interfaces 3rd party controllers via a removable interconnect module. These interconnect modules conform to each manufacturers interconnect cable, and internally route all the command and I/O signals.

Optionally, a Primatics positioning stage can be used with many third party controller and amplifier systems. In this case, a pigtailed cable is available to simplify the connection between the PLG stage and controls.

3) Models

Refer to the PLG Datasheets available from www.primatics.com for current model options. Some options and configurations referenced in this manual have been discontinued. The information remains here for reference only.

4) Personal Safety

Please review before installing your positioning stage

Observe common industrial safety practices when installing and operating automated equipment.

- Have power connections made by qualified personnel.
- Keep fingers and other items out of any opening in the stage while it is in operation since injury or damage may result.
- Provide a safe access route and adequate room for servicing.
- Perform the recommended periodic maintenance described in this document.
- Verify that the work envelope is free of obstructions before the positioning stage is powered.
- Insure that you have the feedback wired properly to the controller before applying power to the positioning stage. Improper feedback connections can cause a motor run-away condition that has the potential to damage the stage and injure an operator.
- Only trained operators of the positioning stage should be allowed near the work environment.
- If so equipped, identify emergency stop circuits and actuators in the workcell.
- Note the places in the workcell where pinch points occur, and provide adequate safety clearance or safety curtain.
- Never operate the motor in a location that could be splashed by water, exposed to corrosive or flammable gases or is near combustible substances since this may cause an electric shock, fire or malfunction.
- Never touch the motor, driver, or peripheral devices when the power is on or immediately after the power is turned off. The high temperature of these parts may cause burns.

5) Conventions

5.1) Direction of Motion

The positive direction of motion is defined as a motion away from the motor end of a stage. A positive direction of motion also signifies the encoder count is increasing. All cables and connectors are located at the motor end of the stage. The reverse limit switch is located on the motor end and the forward limit switch is located on the opposite end of the stage. Figure 5-2 illustrates this convention.

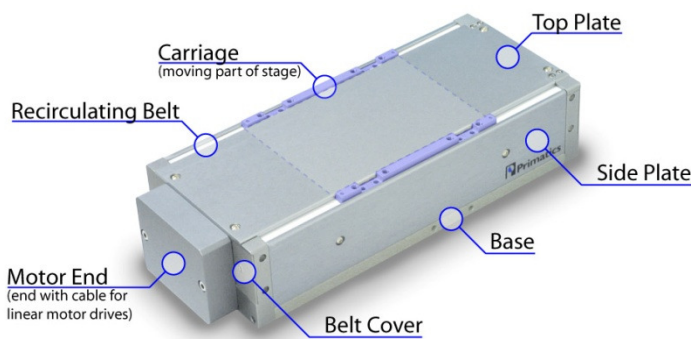

Figure 5-1: Name Conventions

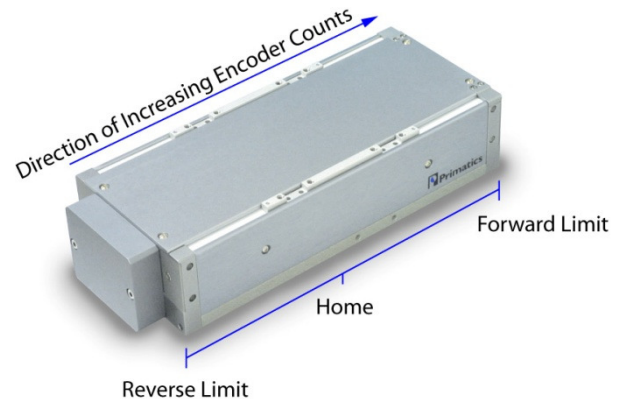

Figure 5-2: Positive direction convention

5.2) Units of Measure

Primatics uses the metric system for all specifications and dimensions. All linear dimensions are specified in millimeters. Accuracy, repeatability, resolution, flatness and straightness for the PLG is specified in microns. Load capacity is specified in kilograms and moment capacity is given in Newton-meters. All torque specifications are given in Newton-meters. Thrust specifications are given in Newtons.

The following table gives some common conversions into English units:

Metric Unit	English Unit
1 Kilogram equals	0.0685 slug*
1 micron equals	0.0000394 inch
1 millimeter equals	0.0394 inch
1 Newton-meter equals	8.85 in-lbs
1 Newton equals	0.2248 lbs
*1 Kg has a weight of 2.205 lb when $g = 9.8 \text{ m} / \text{s}^2$	

6) Installation Preparations

This section outlines installation environments. Unfavorable installation conditions may cause electric shock, fire, or breakdown. Certain breakdown situations or malfunctions in particular may lead to serious injury or other consequences. Assure that the unit is used under the following installation conditions:

- Indoors, free from being splashed by water
- No corrosive or inflammable gases present
- Well ventilated place, minimum level of dust or waste
- An environmental temperature range between 0-40 °C, and humidity between 20-80% RH (location with no condensation) Note - These values show the range in which operation can be carried out safely, but not the environmental range in which stages accuracy can be guaranteed. Stage accuracy can be guaranteed at 20 °C +/- 1 °C.
- Location should not be affected by electrical noise.
- Location should be where inspection and cleaning can be performed without difficulty.

The PLG features built-in protection to counteract some negative environmental effects. Please see section 3, the PLG datasheet, or refer to Table 6-1 below to confirm your selected protection (P) level.

Table 6-1: Protection Level Options

Protection Level	Hardcover	Belts	Clean Grease	High Pressure Purge	High Flow Purge	Class 10 Prep
Level 1 (P1)	Yes	No	Yes	No	No	No
Level 2 (P2)	Yes	Yes	Yes	Yes	No	No
Level 4 (P4)	Yes	No	Yes	No	Yes	Yes
Level 5 (P5)	Yes	Yes	Yes	No	Yes	Yes

6.1) Linear Motors

Linear motors have large magnetic flux that can draw ferrous metals inside them from large distances, destroy magnetic media, and disrupt some electronic circuits. Materials attracted to the magnets can pinch fingers and cause injury. Great care must be taken when operating less than 25mm from the surface of the motor.

In addition, braking is difficult for linear motors making them inappropriate for many vertical applications. Make sure no load is attached to the linear motor stage when stage is first connected to the electronics. Linear motors can generate large accelerations and improper wiring to the control system can result in a high-speed crash.

6.2) Heat and Humidity

All positioning stages are assembled and tested at 20°C. Any stage calibrations are also performed at 20°C. For optimum accuracy the ambient temperature should be maintained at 20°C. Deviations from this nominal temperature may result in degraded accuracy performance.

Large thermal gradients in the interior of the stage can result from motor heat created by high acceleration moves. Care must be taken to limit the duty cycle of the linear motor to maintain stage performance. Airflow across the motor will help minimize thermal expansion effects and increase the allowable duty cycle.

Ballscrew driven stages are also susceptible to thermal expansion effects. The ballscrew nut can create a localized thermal gradient if driven at high speeds. Both high pressure air purge and high flow air purge through the stage can help minimize ballnut heating, the latter being most effective.

6.3) Contamination

Applications in dirty or dusty environments require the electrical, optical and mechanical components to be protected. The standard belt protection and high-pressure (60-90psi)/high flow air purge system (P2) is sufficient for environments generating moderate quantities of 0.5 mm and larger particles. It is important to be aware of the amount of airflow going into the stage; air flowing into a stage can push the belts against the slots that they run in and cause an increase in the amount of drag created by the belts. This can affect the performance of the stage. Adverse effects may include increased settling times or decreased repeatability of the stage.

For dusty environments or applications with continuous exposure to smaller contaminants, an optional low pressure/ high flow purge system is necessary (P5). It allows movement of 5-15 cfm of low-pressure air through each stage. Additional protection must be used for stages that will be splashed with fluids.

Airflow through a stage must be filtered and dry. The filtration system should reject particles larger than 2 microns. Air pressures between 60-100 psi are sufficient for convection cooling. A typical air source can be made suitable with the addition of an inline desiccant dryer and filter/regulator assembly. Humidity should be less than 85% and there should be no condensation in the environment in which the stage is used.

6.4) Electrical Noise

Electrical noise is the corruption of signals carried over low voltage wires. Encoder signals can be corrupted resulting in spurious encoder counts thus causing the stage to drift. Grounding, shielding, and spatial separation are all countermeasures to reduce the influences of electrical noise on performance. You can minimize the potential for electrical noise by observing the following installation precautions:

- Physically separate low voltage conductors from those carrying high voltage.
- Ensure that all components are properly grounded.
- Ensure that all wiring is properly shielded.

6.5) Using the PLG in a Class 10 Cleanroom

For operation in a Class 10 Cleanroom, the PLG stages must be configured with the P4 or P5 Protection options.

6.6) Using the PLG in a Vacuum

Many configurations of the PLG Family are compatible with operation in a vacuum. Contact us for more information.

7) Installing the PLG Positioning Stage

7.1) Tools you will need

To install the PLG stage, you will need the hex wrenches and fasteners listed below. “M” sizes refer to Metric sizes, and fractions refer to English sizes. In reference to screw sizes, the second dimension given refers to the length of the screw in mm. For example, “M4 x 16” would require an M4 screw that is 16 mm long. The term BHSC refers to Button Head Stainless Screws.

Hex Wrench Sizes

	Base Plate	Carriage Plate	Top & Side Plates	Coupling	Motor Mount
PLG110	M3	M2.5	M2	7/64	M4
PLG160	M4	M2.5	M2	7/64	M4
PLG210	M5	M3	M2.5	5/32	M4

Screw Sizes

	Base Plate	Carriage Plate	Top & Side Plates	Motor Mount
PLG110	M4 x 16	(8) M3 x 8, (8) M3 x 12 Zinc Plated Alloy Screws	M3 x 6 BHSC	M5 x 12
PLG160	M5 x 20	(16) M2 x 12 Zinc Plated Alloy Screws	M3 x 6 BHSC	M5 x 12
PLG210	M6 x 16	M4 x 16 Stainless Steel Screws	M4 x 6 BHSC	M5 x 12

7.2) Unpacking

Carefully remove the stage from its shipping crate and inspect it for evidence of shipping damage. Report any damage immediately to your authorized dealer. If so equipped, remove the red shipping clamp from the stage.

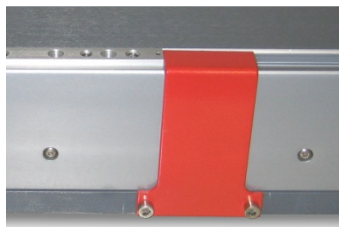

Figure 7-1: PLG210 Shipping Clamp

	Hex Wrench Required
PLG110	M3
PLG160	M3
PLG210	M4

Improper handling of the stage may degrade its performance. Follow these guidelines when handling and mounting your stage.

- 1) Do not drop the stage onto its mounting surface. Place the stage gently on the mounting surface. Impact loads can cause high spots on mounting surfaces, misalignment of drive components and warping of the base.
- 2) Do not drill holes into the stage. If additional holes are necessary, contact your local distributor.
- 3) Lift the stage by its base structure only. Do not lift by the motor drive assembly.
- 4) Stage disassembly and alteration, unless specified otherwise, may void warranty.

7.3) Installing Motors on Ballscrew Stages

If the stage was ordered without a Primatics supplied motor or coupling, the motor and coupling will have to be installed by the user.

7.3.1) In-Line Motor Mounting

The following procedure is used to mount a motor on PLG stages with the M1 Motor Mount Option.

- 1) Install the flexible coupling on the motor shaft.

Note: A Servo Motor with Encoder is shown, but the procedure is similar for a step motor.



- 2) Slip the coupling over the ballscrew shaft and seat the motor in the motor pilot. The coupling clamp bolt should be visible. If the clamp bolt is not visible or the ballscrew shaft does not extend past the clamping bolt, repeat Step 1 and slide the coupling forward or back.

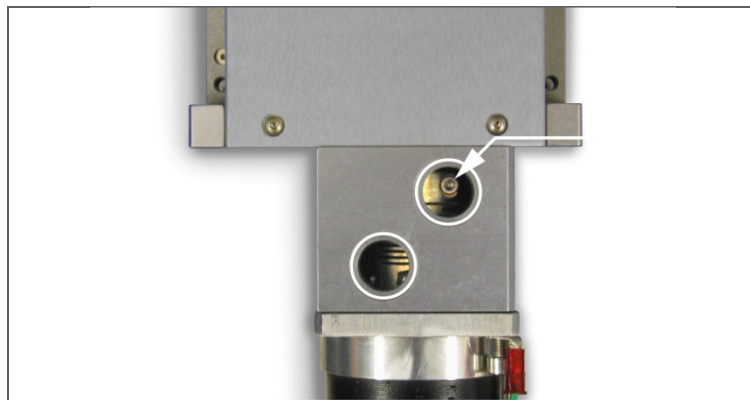

3) Mount the motor to the stage with 4 fasteners. All stages typically use M5 x 12 SHCS.

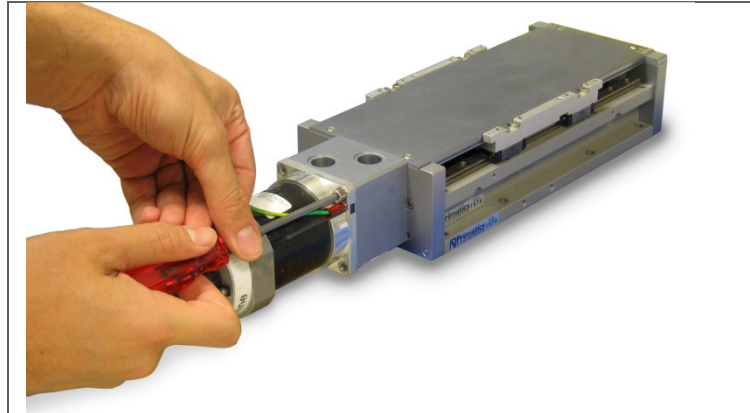

4) Fully tighten the coupling clamp screw.

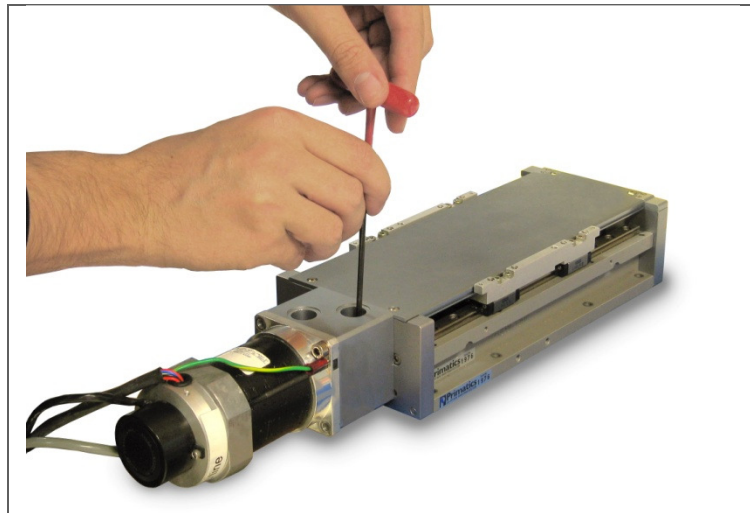

7.3.2) Parallel motor mounting

The following steps describe the process to mount a motor on a Primatics PLG stage with the Parallel motor mount, options M2 (position 1, as seen in the following photos) or M3 (position 2, with the motor mounting in parallel on the other side of the stage). Note: The following photos are for a PLG110 with the M2 option, but the steps are the same for a PLG160 or PLG210 stage as well as the M3 options.

List of tools

	Parallel Housing	Standoff	Ground Wire Screw	Shaft Coupling	Cable Cover	Parallel Housing Cover
PLG110	M3	1/4" Wrench	M2.5	Varies	M2.5	M2
PLG160	M3	1/4" Wrench	M2.5	Varies	M2.5	M2
PLG210	M4	1/4" Wrench	M2.5	Varies	M2.5	M2.5

1) Remove the cover of the parallel mount.

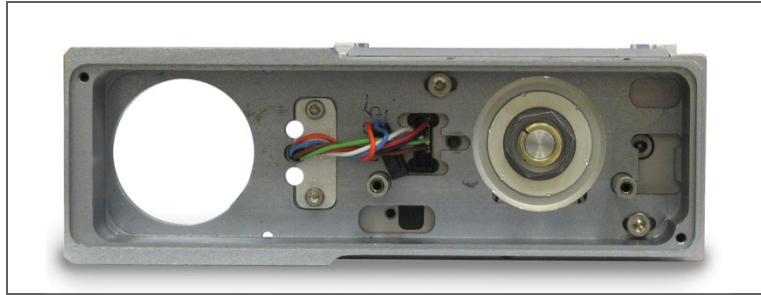

2) Locate the motor shaft coupling, belt pulley and drive belt.

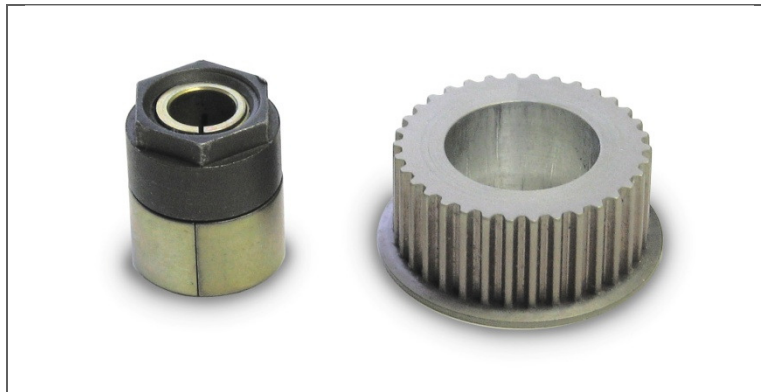

3) Install the pulley and motor shaft coupling on the motor shaft. Use a wrench for the coupling and band wrench (or some other soft tool) to secure the belt pulley.

Motor Shaft	Socket Size
1/4"	1/2"
3/8"	5/8"
8mm	16mm
9mm	16mm
1/2"	3/4"
14mm	22mm



4) Mount motor to parallel mount as shown. The motor pulley should be in the same plane as the drive pulley and spaced about 5mm from the surface of the housing. Repeat Step 3 as necessary. Loop the Belt around both pulleys.

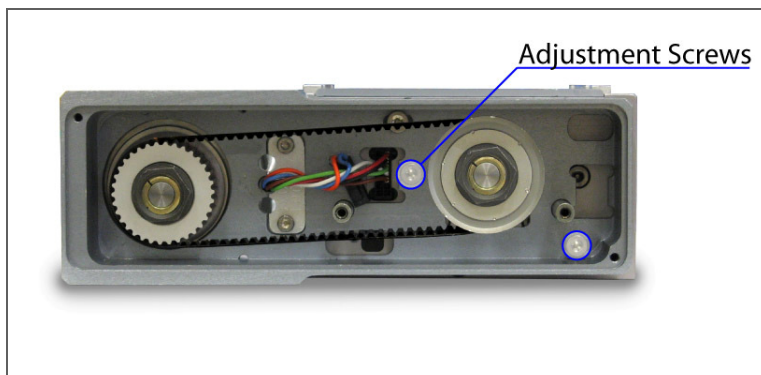

5) Belt tension is adjusted by loosening the fasteners indicated in Step 4 and sliding the motor mount toward the motor. Tighten the adjustment screws to secure the mount in place. Use an M3 Hex Driver for the adjustment screws.

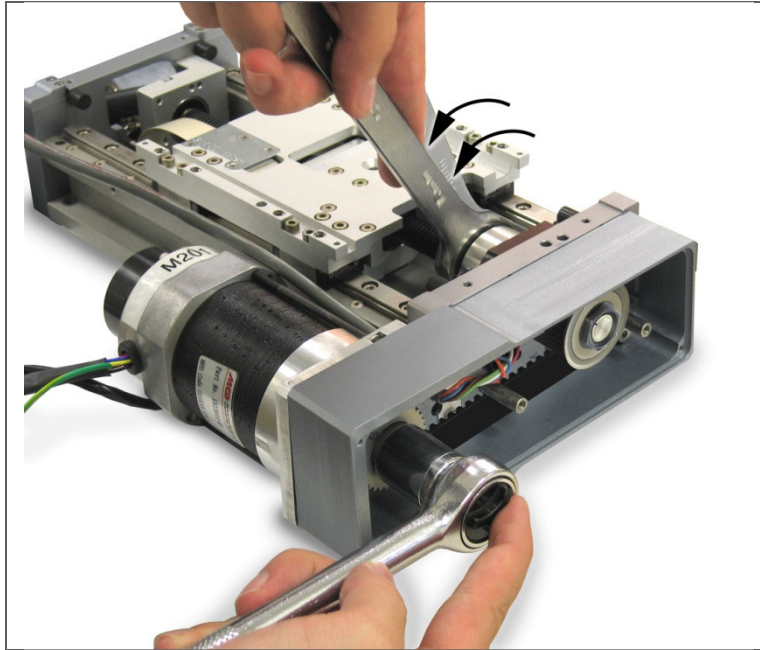

6) Install the cover to the motor mount.

7.4) Mounting surface preparation

The characteristics of the surface the positioning stage is mounted to will have a large effect on system performance. An accurate and flat positioning stage will conform to the shape of its mounting surface, therefore a flat mounting surface is required. In the absence of a sufficiently flat surface, a three point mounting scheme can be utilized to rely on the inherent flatness of the stage. This technique can introduce negative dynamic effects in moment load applications because a large portion of the stage base is not in contact with the mounting surface. The flatness and straightness specifications can be affected under large loads. For best results in maintaining stage specifications we suggest the following:

- 1) Use a laboratory Grade AA granite surface plate
- 2) Before mounting stage, inspect for burrs or dings on the stage mounting surfaces
- 3) Clean all mounting surfaces with acetone

In the absence of a granite surface plate, we recommend a base plate made of the same material as the base of the stage. A mounting surface constructed out of a material different from the stage base material can introduce warping in the stage in the presence of a thermal gradient. The surface flatness should match the requirements of the application; a good starting point is to have the mounting surface flat to less than 5-8 μ m.

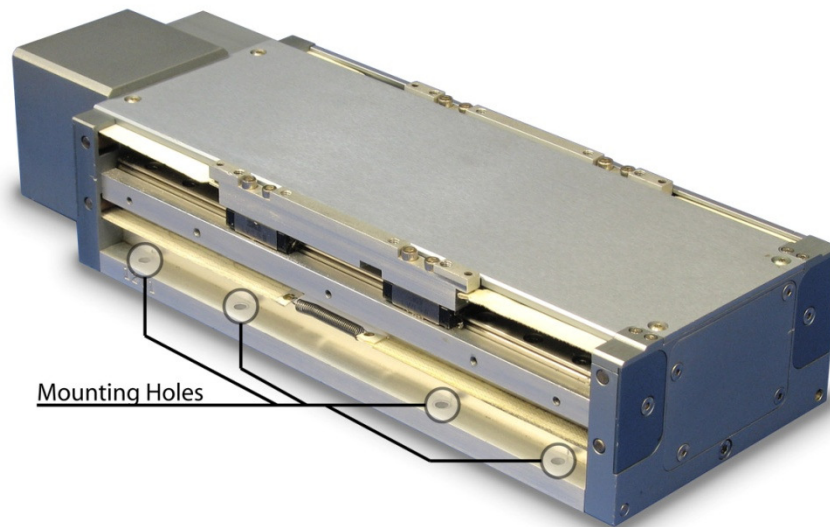

Figure 7-2: Mounting Hole locations

7.5) Mounting the Stage

- 1) Remove Side Covers.
- 2) Insert Mounting Screws.
- 3) Tighten Screws. Access holes are provided for hex tool. When mounting the base down to the surface plate, tighten the bolts at one end of the stage first and move towards the other end.
- 4) Replace Side Covers.

7.6) Electrical Connections

Electrical connections to the stages depend on the type of stage in use. All PLG models with linear motors or frameless motors are terminated with a 450mm flexible cable with a 28 position circular connector on the end. The pin-out of this connector is shown with Table 7-1. This particular configuration is optimized for use with Primatics MDC drive chassis via an extension cable. Connections to other drives and controls are also made through this connector.

PLG models with M1, M2, or M3 Motor Mount options provide all electrical connections through DSub connectors. Models without internal encoders use a 9 position DSub described in Table 7-4. Models with internal encoders use a high-density 15 position DSub described in either Table 7-3 (internal brake option (B2)) or 7-4 (no internal brake option (B1)).

A popular option for applications not using the Primatics MDC drive chassis is the pigtailed extension cable. This is similar to the extension cable used to connect a stage to the MDC drive chassis, except the end that connects to the motor drive and controller is un-terminated. Section 7.6.1 shows the conductor assignments for this cable (when ordered with a ballscrew drivetrain and without an encoder).

**Table 7-1: Axis Connector (Motor, encoder, limits, home, temp)
for Linear motors and frameless motor options**

FCI circular connector, 28 pins, size 20 shell

Pin	Function
A	Motor A
B	Motor B
C	Motor C
D	Motor Shield
E	Encoder 5V – power for encoder
F	Encoder A+ output
G	Encoder A- output
H	Encoder B+ output
J	Encoder B- output
K	Encoder Shield
L	12 - 24VDC - for limit & home
M	DCCOM
N	Home
P	Brake release output (24VDC) for optional brake
R	Brake return for optional brake
S	Stage Base
T	Hall V+
U	Hall V-
V	Encoder 0V
W	Encoder Index +
X	Encoder Index -
Y	Forward Limit Switch
Z	Reverse Limit Switch
a	Signal Shield
b	Hall A
c	Hall B
d	Temperature monitor – connect to DC Common for temperature OK
e	Hall C



**Table 7-2: Stepper Axis Connector
(Motor, encoder, limits, home, temp)**

FCI circular connector, 28 pins, size 20 shell

Encoder signals, pins E-K, W and X, are available only when encoder option is specified in model.

Pin	Function
A	Motor A+
B	Motor B+
C	Motor B-
D	<Key>
E	Encoder 5V
F	Encoder A+
G	Encoder A-
H	Encoder B+
J	Encoder B-
K	Encoder Shield
L	Limit Sensor Power (12VDC)
M	DCCOM
N	Home (Reserved, N.C.)
P	Not Used
R	Not Used
S	Chassis Ground
T	Motor A-
U	Motor B Common (No internal connection)
V	Encoder Ground
W	Encoder Index +
X	Encoder Index -
Y	Forward Limit Sensor
Z	Reverse Limit Sensor
a	Motor Shield
b	Motor A Common (No internal connection)
c	DCCOM
d	Temp Sensor (Not Used, Connected to DCCOM)
e	Not Used

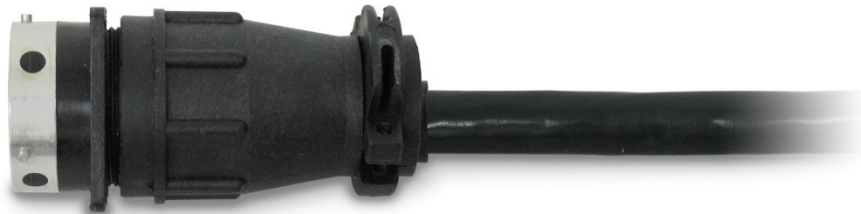

Table 7-3: Signal Connector: Internal encoder, limits, home, and brake for Ballscrew motor with encoders and brake
Hi-Density Male Dsub 15P

Pin	Function
1	12 - 24VDC – for limit & home
2	DCCOM
3	Forward Limit Switch
4	Reverse Limit Switch
5	Home
6	Brake release output (24VDC)
7	Brake return
8	Encoder 5V (power for encoder)
9	Encoder 0V
10	Encoder A+ output
11	Encoder A – output
12	Encoder B+ output
13	Encoder B – output
14	Encoder Index + output
15	Encoder Index – output

Table 7-4: Signal Connector: Internal encoder, limits, home, no brake for Ballscrew motor with encoders and no brake
Hi-Density Male Dsub 15P

Pin	Function
1	12 - 24VDC – for limit & home
2	DCCOM
3	Forward Limit Switch
4	Reverse Limit Switch
5	Home
6	No connection
7	Encoder shield
8	Encoder 5V (power for encoder)
9	Encoder 0V
10	Encoder A+ output
11	Encoder A – output
12	Encoder B+ output
13	Encoder B – output
14	Encoder Index + output
15	Encoder Index – output



**Table 7-5: Signal Connector: Limits, home, brake (no internal encoder)
for Ballscrew motor with no encoder**

Male DSub 9P

Pin	Function
1	12 – 24 VDC – for limit & home
2	DCCOM
3	Forward Limit Switch
4	Reverse Limit Switch
5	Home
6	Brake release output (24VDC) for optional brake
7	Brake return for optional brake
8	No connection
9	No connection



7.6.1) Color Codes for Pigtailed Cable

Cable consists of 3 independent shielded “pods”: One for motor signals, one for encoder signals & a 3rd for sensors and brake. Each of the pods is described below.

Cable 1

	Color	Function
■	Black	Motor R
■	Red	Motor S
□	White	Motor T
■	Shld	Motor Shield

Cable 2

	Color	Function
■	Red	Encoder 5V
□	White	Encoder A+ output
■	Yellow	Encoder A- output
■	Green	Encoder B+ output
■	Blue	Encoder B- output
■	Shld	Encoder Shield
■	Black	Encoder Common
■	Orange	Encoder Index +
■	Brown	Encoder Index -



Cable 3

	Color	Function
■	Green	12VDC
■	Blue	DCCOM
□	White	Home
□ / ■	Wht/Red	Brake release output (24VDC)
□ / ■	Wht/Black	Brake return
■	Shld	Chassis
■	Black	Hall V+
■	Brown	Hall V-
■	Violet	Forward Limit Switch
■	Gray	Reverse Limit Switch
■	Red	Hall A
■	Orange	Hall B
■	Tan	Temperature Monitor
■	Yellow	Hall C

7.6.2) Hall Effect Commutation Sequence

In the event that user amplifier and controls are being implemented, use the following motor commutation timing charts.

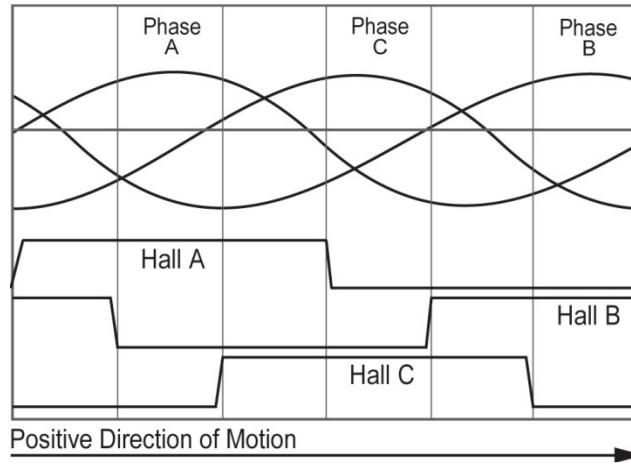

Figure 7-3: Motor commutation chart

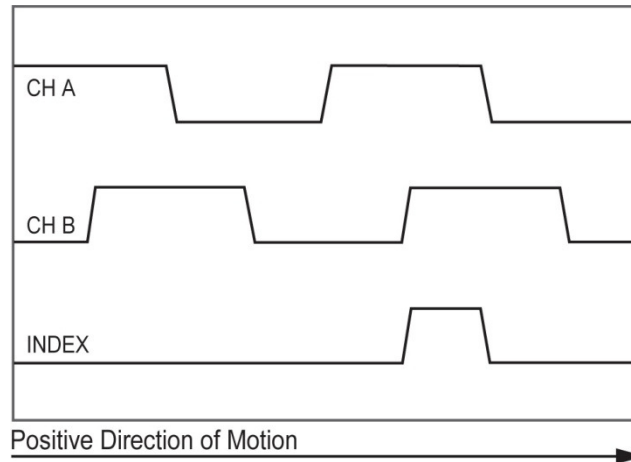

Figure 7-4: Timing diagram for the encoder signals

7.7) Home and Limit Sensors

Each PLG stage includes Forward and Reverse Limit sensors and a Home sensor. Models ordered with internal motors also include a Motor Temperature Switch. Figure 7-4 shows the equivalent schematic for these switches.

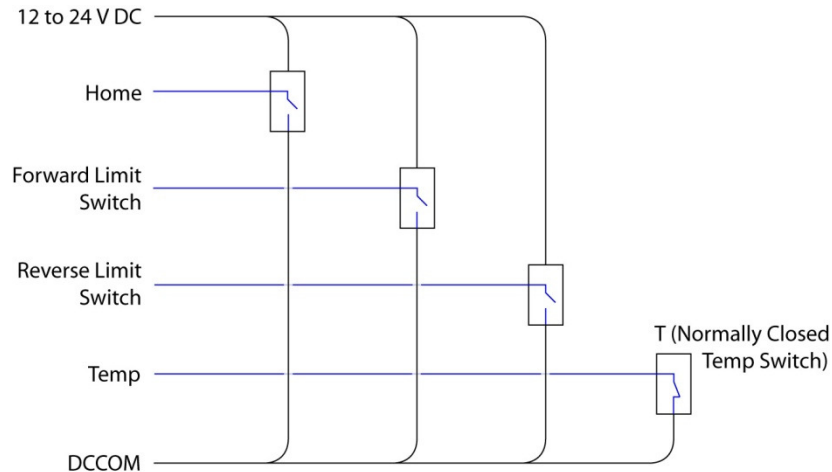

Figure 7-4: Equivalent Limit, Home, and Temp circuit schematic

7.7.1) Home Options:

The Home switch is ordered in either the Normally Closed (H1) or Normally Open (H2) configuration

H1: Switch is closed when carriage is between the negative (reverse) end of travel and the home transition point. It is open from the transition point to forward end of travel.

H2: Switch is open when carriage is between the negative (reverse) end of travel and the home transition point. It is closed from the transition point to forward end of travel.

7.7.2) Limit Options:

The Limit switches are ordered in either the Normally Closed (L1) or Normally Open (L2) configuration

L1: When the carriage is in the normal operating range of travel, both limit switches are closed. When the carriage encounters a limit the switch opens. The switch will close again when the carriage is moved away from the switch.

L2: When the carriage is in the normal operating range of travel, both limit switches are open. When the carriage encounters a limit the switch closes. The switch will open again when the carriage is moved away from the switch.

7.8) Limit and Home Switch Adjustment

The limit and home switch positions are preset at the factory. The limits are nominally set to yield slightly more travel than specified in the model configuration. The nominal home switch transition point is about 2mm to the positive side of the center of travel. Figure 7-5 shows the default signal transition points for a 200mm travel stage.

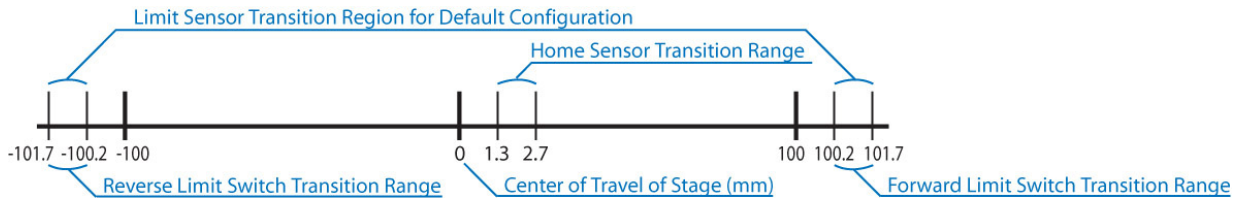

Figure 7-5: Limit and Home Sensor Transition Ranges

The home and limit signals are each produced by separate reflective sensors mounted to the underside of the carriage. A white reflective strip (the home vane) mounted on the inside of the stage runs the length of the stage and is viewed by each sensor. A special non-reflective black tape is applied to the home vane. Each switch is closed when viewing the white area and is open when viewing the non-reflective tape. Figure 7-6A shows the tape configuration for the normally closed sensor options (H1, L1). Figure 7-6B shows the tape configuration for the normally open sensor options (H2, L2). The point at which each signal transition occurs can be adjusted by adding or removing the non-reflective tape. The home sensor can also be reconfigured to a momentary switch by adding or removing tape.

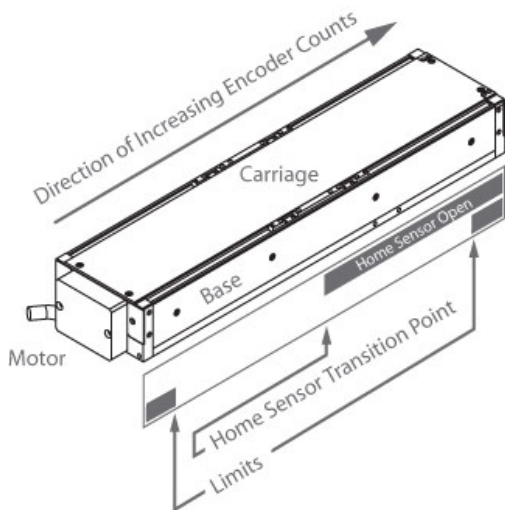

Figure 7-6A: Home Vane Configuration H1, L1 Options (Normally Closed)

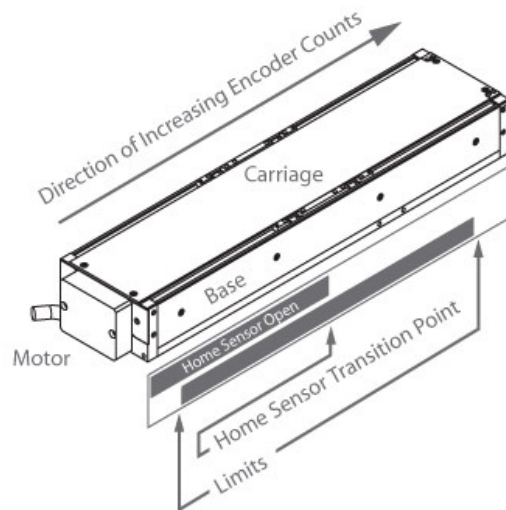

Figure 7-6B: Home Vane Configuration H2, L2 Options (Normally Open)

Adjustment of the limit and home positions can be achieved easily. The white metal strip on the interior of the stage has three pieces of black tape affixed to it. The bottom half of the strip contains two narrow pieces of tape that correspond to the limit switch positions. The limits transition points can be moved by adding additional black tape to the white strip. No adjustment of cables is necessary. The home transition point can be moved as well or converted to a momentary switch in a similar fashion. A 3 inch length of tape is supplied with each stage for this purpose. Longer pieces are available upon request. The Top Cover must be removed to gain access to the Home Vain. Figure 7-7 shows the Top Cover fastener locations.

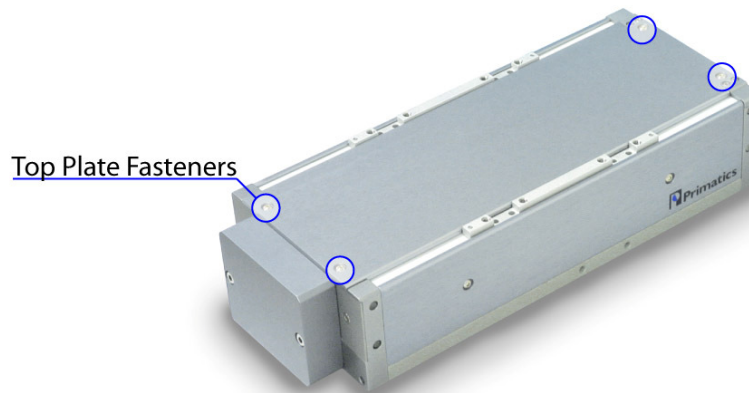

Figure 7-7: Top Cover fastener locations

7.9) Recommended System Test

Before attaching a load or applying power to your stage, verify the encoder and limit switches are working properly. Move the stage carriage by hand in the positive direction and verify the encoder count is increasing. Runaway conditions caused by miswired encoders can result in stage damage and personal injury. Move the carriage to each end of travel to ensure limit switches are working properly. When closing the position loop for the first time, set the torque limit of your controller to a low value and use conservative tuning gains. Once the control loop is working properly, payloads can be added to the stage carriage.

8) Preventive Maintenance

Performing preventive maintenance procedures on your stage will extend its life and improve its long-term performance.

8.1) Lubrication

Use clean room grease to lubricate the ballscrew and linear guide components. We recommend NSK grease part #GRS LG2. For low duty cycle applications, it is recommended that the ballscrew and linear guides are re-greased every six months. High duty cycle applications may require more frequent re-lubrication. Lubrication intervals depend on duty cycle, load and ambient conditions. Inspection of the drivetrain elements may be required to determine the proper lubrication interval. Primatics offers a grease kit that has all the necessary hardware to re-lubricate the ballscrew and linear bearings.

To gain access to component grease ports, remove the stage side plates. On the end of each bearing block is a small hole where grease is injected using a syringe (see Figure 8-1). The ballnut in ballscrew drive models must be lubricated. Beneath the carriage a grease tube with a 3mm nipple is located between the bearing blocks on the side opposite the home/limit strip (see Figure 8-2). It supplies the ball-nut with grease. Use a grease gun with a mating coupler.

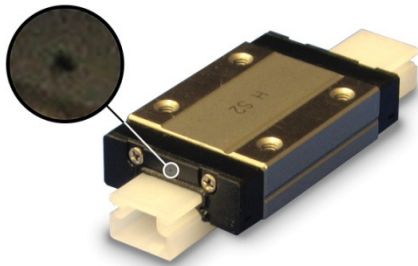

Figure 8-1: Bearing block lubrication port

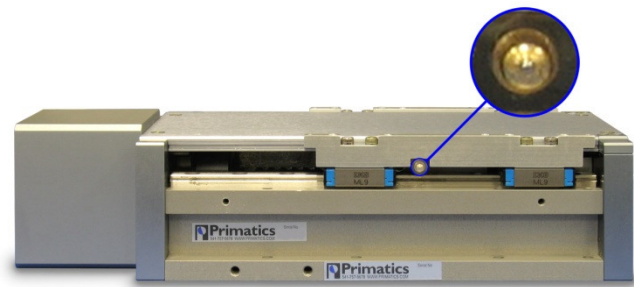

Figure 8-2: Ballscrew lubrication port

If the stage has re-circulating belts, upon reinstalling the side covers, make sure the belts engage both the top and side cover containment grooves. In the event that the top cover has been removed, replace the top cover first and insert the belts into the containment grooves before replacing the side covers. When replacing the side covers, insert the belts into the containment grooves before attempting to tighten down the mounting hex screws. Failure to seat the belts properly will compromise the sealing system and reduce belt life.

8.2) Protection Belts

Protective belts can be ordered with the PLG stages under the P2 or P5 options. The belts are made of a polymer with a polyurethane coating that will provide millions of cycles of use. In a dirty environment particles deposited on the belts may collect into a small area in the endplates. Removal of the belt end plate covers (see Figure 8-3) gains access to this area. Periodic cleaning of this area is necessary.

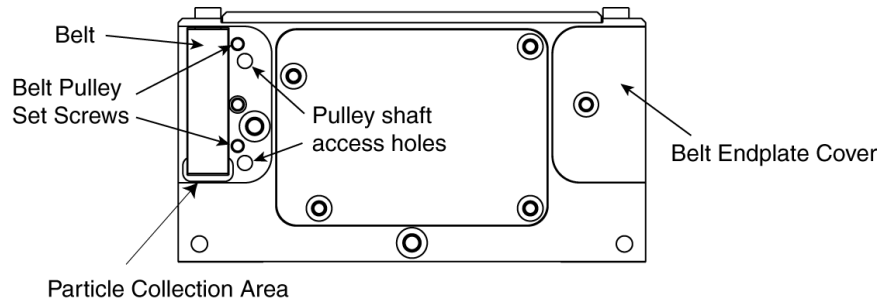
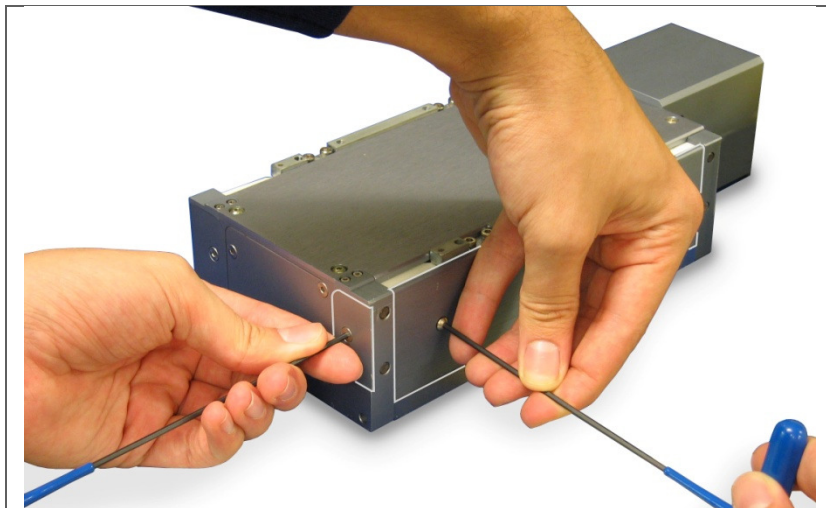

Figure 8-3: Protection Belt anatomy

8.2.1) Replacing Belts at the End Opposite of the Cable Exit

To replace the belts on the end opposite of the cable exit, use the following procedure:

1) Remove belt covers (outlined in white).



2) Remove belt from carriage plate pins. This may require a small regular screwdriver to pop off the belts.

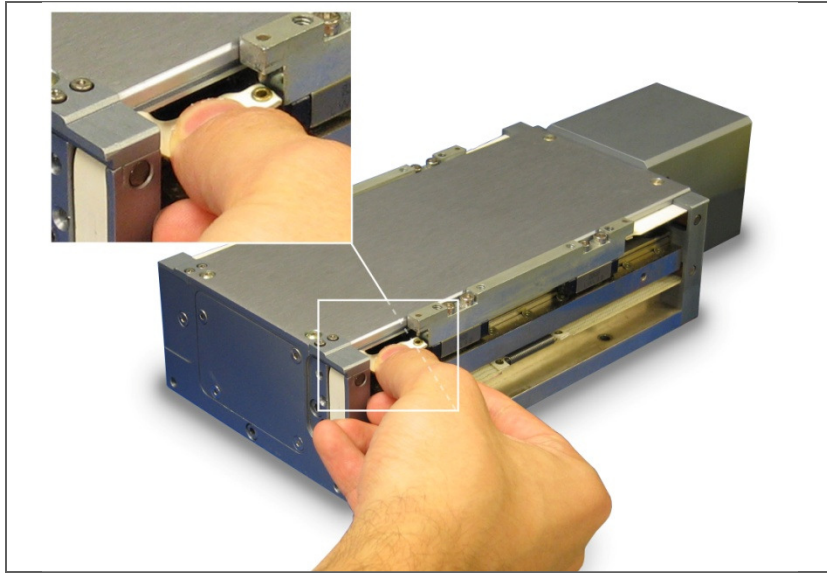

3) Turn seal pulley set screw ¼ turn counterclockwise. Insert 1.5mm hex screwdriver into the pulley access hole and pop out the pulley shaft.

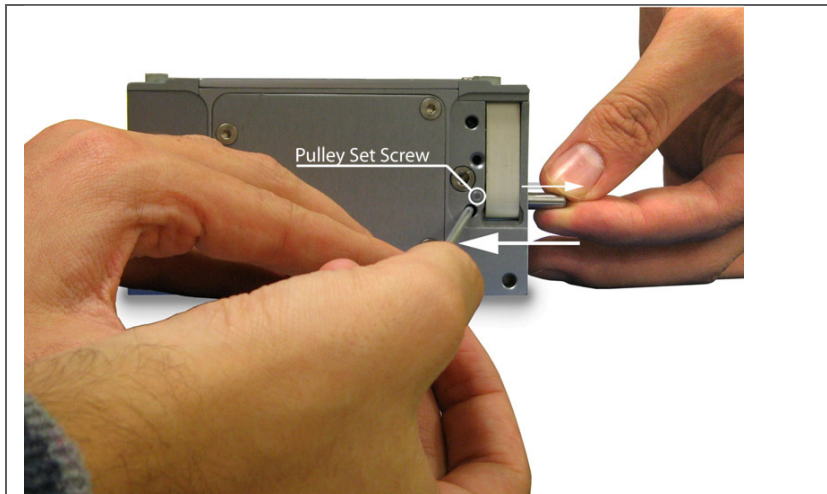

4) Loosen top cover to give enough clearance for the belt. Remove the belt.

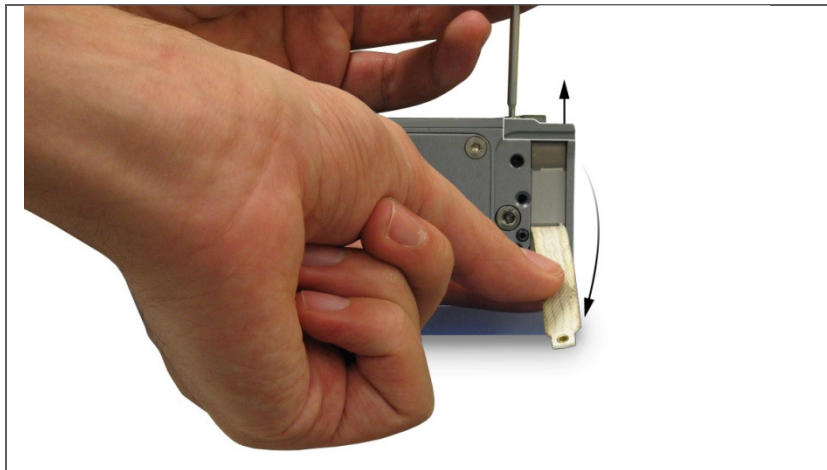

Follow this procedure for the other 3 belts. Follow the reverse procedures to install new belts. Make sure you attach the spring before attempting to attach the belts to the carriage belt pins.

8.2.2) Replacing Belts at the End of the Cable Exit

To replace the belts on the motor end of the stage requires additional steps depending on the motor mount. Follow these additional steps when replacing the belts:

8.2.2.1) Parallel Mount Motor Stages

- 1) Remove parallel motor housing outer cover.
- 2) Remove the two hex screws that attach motor housing to the endplate with M2.5 hex tool.
- 3) Remove motor housing.
- 4) Follow instructions provided in 8.2.1

8.2.2.2) Nema 23 In-Line & Frameless Motor Stages

- 1) Remove the two hex screws on the cable exit box with a M2.5 hex tool.
- 2) Remove cable exit box.
- 3) Follow instructions provided in 8.2.1

8.2.2.3) Linear Motor Stages

- 1) Remove the two hex screws that attach the cable exit housing to the endplate with a M3 hex tool.
- 2) Remove cable exit housing. Disconnecting the cable should not be necessary.
- 3) Follow instructions provided in 8.2.1

9) Troubleshooting & Service

9.1) Troubleshooting FAQ's

° What are typical applications for the PLG?

PLG stages are typically used in applications such as material handling, electronic assembly, inspection, metrology, and process automation with high levels of required precision.

° Do all the positioning stages in a family have the same dimensions?

The PLG110, PLG160 and PLG210 are considered separate stage families. The in-line, frameless, parallel and linear motor versions of each family of stages have identical height and width dimensions, but the total length varies slightly depending on the model. Although the body of the parallel mount stage has identical dimensions to the others, the motor mount itself is wider than the rest of the stage.

° Can PLG stages be used in multi-axis configurations?

Yes. PLG stages can be stacked or mounted using brackets. PLG110s can be mounted directly to PLG110s, PLG160s can be mounted directly to PLG160s, and PLG210s can be mounted directly to PLG210s. Additionally, PLG160s can be mounted directly to PLG210s. All other configurations require mounting brackets. Mounting bracket drawings are available from our website.

° Can PLG stages be used with other Primatics stages and motion controls?

Yes. PLG stages can be mounted in multi-axis configurations with other Primatics stages for a greater range in motion.

° Can PLG stages be used with third party motors, drives and controls? What kinds of motors are these?

Yes, in the simplest case the PLG with a ballscrew drivetrain can be ordered with no motor. Any standard NEMA 23 size motor can be used with either the in-line or parallel mount configurations in PLG110s and PLG160s. Any standard NEMA 34 size motor can be used with either in-line or parallel mount configurations in PLG210s. A coupler can be ordered from Primatics or the user can provide their own coupler. For PLGs being used without Primatics drives and controls there are a variety of pigtail assemblies that can be ordered to interface our stages to your drives.

° Can PLG stages be used in gantry configurations?

Yes. In a typical XY configuration, two stages placed in parallel form the X motion and a third stage spanning the two create the Y motion. An available accessory is a passive, non-motor-driven stage, but is dimensionally equivalent to a standard motor-driven stage. This can be used as one of the two stages placed in parallel.

° Can PLG stages be mounted vertically?

Yes. For information on how load capacities change please see the PLG datasheets available on our website.

° Can the PLG be used in clean rooms?

Yes. The PLGs can be ordered for class 10 cleanroom. Class 1000 cleanroom is standard. Ordering options for cleanroom enabled stages are discussed in Section 6.4.

° Can the PLG be used in vacuum?

Yes. The PLGs can be ordered for operation in vacuum. Ordering options for vacuum enabled stages are discussed in Section 6.4.

° Can the PLG be used in “dirty” environments?

Yes. The PLGs offer several levels of protection for applications in “dirty” environment. The first level of protection includes a hard cover shell over the length of travel. The second level of protection includes our proprietary recirculating belt system. All stages with these belts come with a high pressure air purge, as well as an optional high flow air purge.

° Is there a brake option for the Linear Motor drivetrain?

No.

° Where should I mount the stage for optimal performance?

For optimal performance at high encoder resolutions, the PLG stage should be mounted on a smooth granite surface.

° Can the home and limit sensor locations be changed?

Unless ordered otherwise, the home and limit sensors are set in a standard way at the factory. Custom home and limit sensor locations can be ordered, and they can also be set by the user as demonstrated in Section 8.5.

° Do you have problems with noise coupling between the power and feedback flex cables?

As in all cable management systems, care must be taken to isolate high and low level signals to prevent cross-coupling of noise. Primatics has taken steps to electrically isolate the flex cables from each other to minimize noise problems.

° Are the flexible flat cables susceptible to melting in peak current conditions?

All cables follow a simple rule: the maximum current a conductor can carry before failure is proportional to the cross section of the copper in the conductor. Flexible flat cables are no

different. We have designed our flex cables to be able to withstand the maximum current draw of the motor without damage.

° How does a frameless motor work?

A frameless motor works exactly the same as a brushless servomotor. The only difference is that the rotor magnets are placed directly on the ballscrew shaft. The ballscrew acts as the motor's rotor. This improves the dynamic response of the stage since a compliant coupler is no longer in the system. In addition, the stage is shortened by several inches.

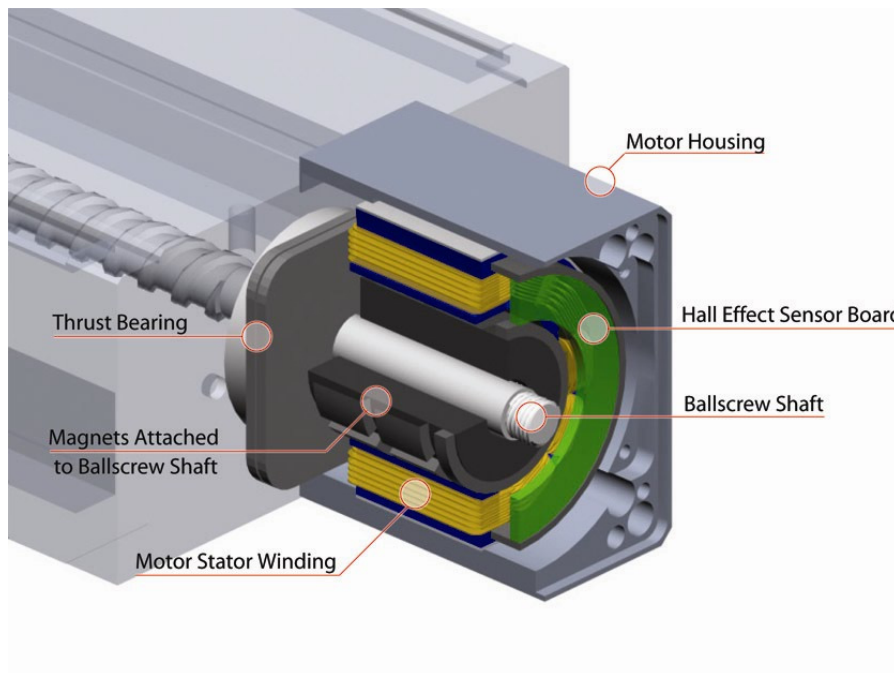

Figure 9-1: Frameless Motor Cutaway

° Where can I get more information about the PLG?

For downloadable brochures, datasheets and CAD models go to our website at www.primatics.com. You may also contact your distributor or the factory at 888-754-3111 or 541-791-9678 or email info@primatics.com

9.2) Troubleshooting Help

For further assistance contact the factory:
M-F 8AM to 5PM Pacific Time

Phone:	[541] 791-9678
Fax:	[541] 791-9410
Toll Free:	[888] 754-3111
Web:	www.primatics.com
E-mail:	service@primatics.com

9.3) Service

Should your device require factory service, contact the factory for a Return Materials Authorization (RMA). When inquiring about an RMA please have the following information available:

- Your contact information (name, phone, email, address)
- Unit Serial Number
- Symptom of problem
- History of troubleshooting steps already taken



Figure 9-1: Unit Serial Number Location