

PDR Series Reference & Maintenance Manual



**2101 NE Jack London St.
Corvallis, OR 97330
U.S.A.**



Phone: [541] 791-9678
Fax: [541] 738-4370
Web: www.primatics.com
E-mail: info@primatics.com

**PDR Manual
Revision Information**

Publication Date	Notes
Jan 2015	New Version, New Logo
Aug 2015	Corrected section 6.4 to include home sensor
Oct 2018	Corrected Primatics address

Notice: The descriptions, drawings, and specifications contained herein are subject to change. Primatics is not responsible for errors or omissions herein or for incidental damages in connection with the furnishing or use of this information. This document shall not be reproduced, photocopied, or duplicated, in whole or in part, without prior written approval of Primatics Corporation.

©Copyright 2015 by Primatics, Inc; All Rights Reserved. Primatics, the Primatics logo, PrimaFlex, PrimaSeal & SimpleMatch are trademarks of Primatics, Inc.

PDR Manual Revision Information	2
1) Overview	4
2) Introduction – About the PDR family	5
 3) Personal Safety 	6
4) Stage & Manual Conventions	7
4.1) Direction of Motion	7
4.2) Units of Measure	7
5) Installation Preparation	8
5.1) Heat and Humidity	8
5.2) Environment	8
5.3) Electrical Noise	9
6) Installing the PDR Positioning Stage	10
6.1) Tools you will need	10
6.2) Unpacking	10
6.3) Mounting surface preparation	10
6.4) Electrical Connections	11
6.4.1) Hall Effect Commutation Sequence	12
6.4.2) Encoder Timing Diagram	12
6.5) Home Switch	13
6.6) Recommended System Test	14
7) Preventive Maintenance	15
8) Troubleshooting & Service	16
8.1) Troubleshooting Help	16
8.2) Service	16

1) Overview

This user guide is designed to help you install and maintain your positioning stage application. Follow these steps to ensure correct stage installation and maximum stage life:

- Step 1* Review this entire user manual. Become familiar with all installation procedures prior to integrating your system.
- Step 2* Review the safety summary to develop an understanding of standard safety practices when installing and operating automated equipment.
- Step 3* Familiarize yourself with the conventions summary.
- Step 4* Review installation procedures. For best results, follow these procedures carefully.
- Step 5* Once you successfully complete all the installation procedures, you will be ready to install and operate your stage.
- Step 6* Review preventive maintenance section for proper lubrication schedule.

2) Introduction – About the PDR family

The PDR Series is a precision continuous travel rotary stage. It incorporates a direct drive brushless servo motor and high resolution encoder in a small package. It comes in three sizes; the base of the stage is square with dimension 110, 160 and 210 mm. The corresponding diameters of the platen (the part that rotates) are 110, 155, and 210 mm, respectively. A high precision glass scale rotary encoder is directly coupled to the rotating platen. A home switch and index pulse on the encoder are used for determining a repeatable home position.

Many customers choose the Primatics Motion Drive Chassis (MDC) to power PDR stages. The MDC is a modular system that packages motor drivers, encoder interfaces, power supplies and safety systems into a single chassis. It acts as an intermediary between a Galil Optima, National Instruments 7344 and Delta Tau PMAC II motion control cards and a Primatics positioning stage. Pre-wired high-flex cables are available to allow a convenient connection from the stage to the MDC chassis. The MDC drive chassis interfaces 3rd party controllers via a removable interconnect module. These interconnect modules conform to each manufacturers interconnect cable, and internally route all the command and I/O signals. The PDR can also be used with user supplied drives and controls.

Electrical interface to the PDR is through a single robust industrial connector at the end of a short flexible cable. This configuration allows the PDR to be fit into small spaces.

3) Personal Safety

Please review before installing your positioning stage

Observe common industrial safety practices when installing and operating automated equipment.

- Have power connections made by qualified personnel.
- Keep fingers and other items out of any opening in the stage while it is in operation since injury or damage may result.
- Provide a safe access route and adequate room for servicing.
- Perform the recommended periodic maintenance described in this document.
- Verify that the work envelope is free of obstructions before the positioning stage is powered.
- Insure that you have the feedback wired properly to the controller before applying power to the positioning stage. Improper feedback connections can cause a motor run-away condition that has the potential to damage the stage and injure an operator.
- Only trained operators of the positioning stage should be allowed near the work environment.
- If so equipped, identify emergency stop circuits and actuators in the workcell.
- Note the places in the workcell where pinch points occur, and provide adequate safety clearance or safety curtain.
- Never operate the motor in a location that could be splashed by water, exposed to corrosive or flammable gases or is near combustible substances since this may cause an electric shock, fire or malfunction.
- Never touch the motor, driver, or peripheral devices when the power is on or immediately after the power is turned off. The high temperature of these parts may cause burns.

4) Stage & Manual Conventions

4.1) Direction of Motion

The positive direction of motion is defined as a rotation in the counter clockwise direction as one is looking down on the stage platen. The encoder is wired so that the encoder count increases as the stage rotates in the positive direction. Figure 5-1 illustrates this convention.. Figure 4-1 illustrates this convention.



Figure 4-1: Positive direction convention

4.2) Units of Measure

Primatics uses the metric system for all specifications and dimensions. All linear dimensions are specified in millimeters. Angular displacement is specified in degrees. Accuracy error and repeatability for the PDR is expressed in arc-seconds (1 degree = 3600 arc-seconds). Load capacity is specified in kilograms and moment capacity is given in Newton-meters. All torque specifications are given in Newton-meters. Thrust specifications are given in Newtons.

The following table gives some common conversions into English units:

Metric Unit	English Unit
1 Kilogram equals	0.0685 slug*
1 micron equals	0.0000394 inch
1 millimeter equals	0.0394 inch
1 Newton-meter equals	8.85 in-lbs
1 Newton equals	0.2248 lbs
*1 Kg has a weight of 2.205 lb when $g = 9.8 \text{ m} / \text{s}^2$	

5) Installation Preparation

This section outlines installation environments. Unfavorable installation conditions may cause electric shock, fire, or breakdown. Certain breakdown situations or malfunctions in particular may lead to serious injury or other consequences. Assure that the unit is used under the following installation conditions:

- Indoors, free from being splashed by water
- No corrosive or inflammable gases present
- Well ventilated place, minimum level of dust or waste
- An environmental temperature range between 0-40°C, and humidity between 20-80% RH (location with no condensation) Note - These values show the range in which operation can be carried out safely, but not the environmental range in which stages accuracy can be guaranteed. Stage accuracy can be guaranteed at 20°C +/- 1°C.
- Location should not be affected by electrical noise.
- Location should be where inspection and cleaning can be performed without difficulty.

5.1) Heat and Humidity

All positioning stages are assembled and tested at 20°C. Any stage calibrations are also performed at 20°C. For optimum accuracy the ambient temperature should be maintained at 20°C. Deviations from this nominal temperature may result in degraded accuracy performance.

Humidity should be less than 85% and there should be no condensation.

5.2) Environment

The PDR series is intended for clean environments free from particulate and fluids. Additional protection must be designed for stages that are in dirty environments.

The PDR Series stages have an optional high pressure/low flow air system. Remove the screw shown in Figure 5.-1 and replace with an M5 air fitting.

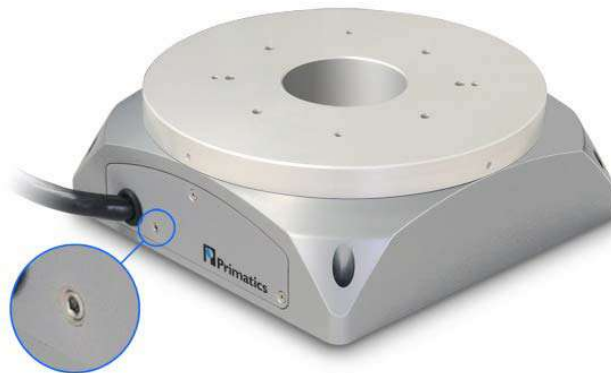

Figure 5-1: High Pressure / Low flow port

Airflow through a stage must be filtered and dry. The filtration system should reject particles larger than 2 microns. Air pressures between 30-50 psi are sufficient for convection cooling. A typical air source can be made suitable with the addition of an inline desiccant dryer and filter/regulator assembly. Humidity should be less than 85% and there should be no condensation in the environment the stage is used in.

5.3) Electrical Noise

Electrical noise is the corruption of signals carried over low voltage wires. Encoder signals can be corrupted resulting in spurious encoder counts thus causing the stage to drift. Grounding, shielding, and spatial separation are all countermeasures to reduce the influences of electrical noise on performance. You can minimize the potential for electrical noise by observing the following installation precautions:

- Physically separate low voltage conductors from those carrying high voltage.
- Ensure that all components are properly grounded.
- Ensure that all wiring is properly shielded.

6) Installing the PDR Positioning Stage

6.1) Tools you will need

The PDR Series uses the following fasteners

	Base	Rotating Platen
PDR110	M4 SHCS	M4 SHCS
PDR160	M5 SHCS	M5 SHCS
PDR210	M6 SHCS	M5 SHCS

6.2) Unpacking

Carefully remove the stage from its shipping crate and inspect it for evidence of shipping damage. Report any damage immediately to your authorized dealer.

Improper handling of the stage may degrade its performance. Follow these guidelines when handling and mounting your stage.

- 1) Do not drop the stage onto its mounting surface. Place the stage gently on the mounting surface. Impact loads can cause high spots on mounting surfaces, misalignment of drive components and warping of the base.
- 2) Do not drill holes into the stage. If additional holes are necessary, contact your local distributor.
- 3) Lift the stage by its base structure only. Do not lift by the motor drive assembly.
- 4) Stage disassembly and alteration, unless specified otherwise, may void warranty.
- 5) Remove the red shipping brackets prior to use.

6.3) Mounting surface preparation

The characteristics of the surface the positioning stage is mounted to will have a large effect on system performance. An accurate and flat positioning stage will conform to the shape of its mounting surface, therefore a flat mounting surface is required. For best results in maintaining stage specifications we suggest the following:

- 1) Use a laboratory Grade AA granite surface plate
- 2) Before mounting stage, inspect for burrs or dings on the stage mounting surfaces
- 3) Clean all mounting surfaces with acetone

In the absence of a granite surface plate, we recommend a base plate made of the same material as the base of the stage. A mounting surface constructed out of a material different from the stage base material can introduce warping in the stage in the presence of a thermal gradient. The surface flatness should match the requirements of the application; a good starting point is to have the mounting surface flat to less than 5-8 μ m.

6.4) Electrical Connections

All PDR models are terminated with a 450mm flexible cable with a 28 position circular connector on the end. The pin-out of this connector is shown with Table 6-1. No other connections are necessary for the PDR.

Table 6-1: Axis Electrical Connector, FCI circular connector, 28 pins, size 20 shell

Pin	Function
A	Motor A
B	Motor B
C	Motor C
D	Motor Shield
E	Encoder 5V – power for encoder
F	Encoder A+ output
G	Encoder A- output
H	Encoder B+ output
J	Encoder B- output
K	Encoder Shield
L	Sensor power (12-24VDC)
M	Sensor common
N	Home sensor
P	Not used
R	Not used
S	Signal Shield
T	Hall V+
U	Hall V-
V	Encoder common
W	Encoder Index +
X	Encoder Index -
Y	Forward Limit – see Note
Z	Reverse Limit – see Note
a	Key
b	Hall A
c	Hall B
d	Not used
e	Hall C

Note: The PDR series does not include limit sensors. The Limit Signal options are provided for compatibility with motion controller requirements.

6.4.1) Hall Effect Commutation Sequence

The following diagram shows the motor signal timing for the Servo Motor option

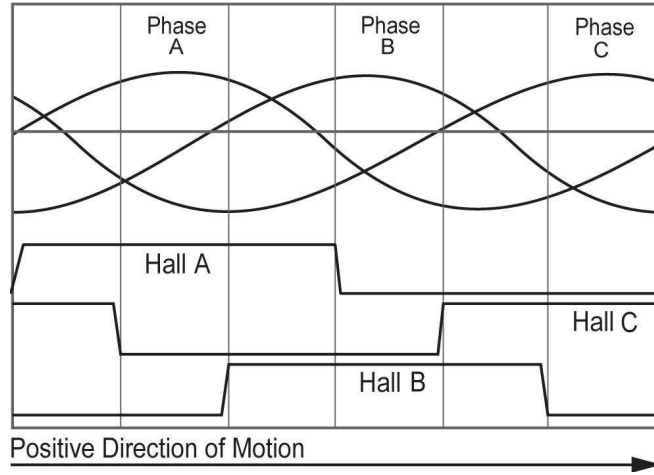

Figure 6-1: Motor Phase and Hall Sensor Timing

6.4.2) Encoder Timing Diagram

The following diagrams show the signal timing for the Encoder options

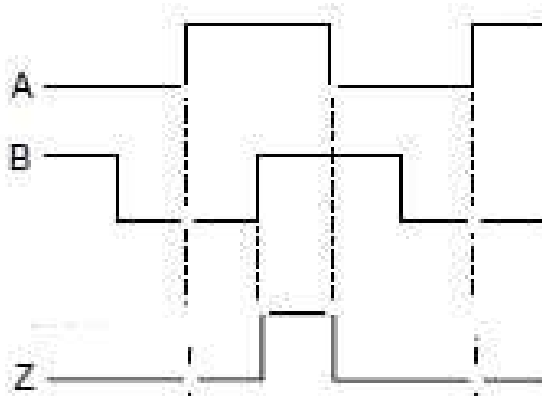

Figure 6-2: Timing diagram for digital encoder signals

6.5) Home Switch

The home switch uses a reflective sensor located in the base of the stage. A white reflective strip runs the circumference of the stage and is viewed with this reflective sensor. 180° of this strip is covered with a black mask. When the sensor is over the white area, the output signal conducts current and closes the home switch. When the sensor is over the black, the switch is open. The home switch is fixed at the factory and cannot be adjusted.

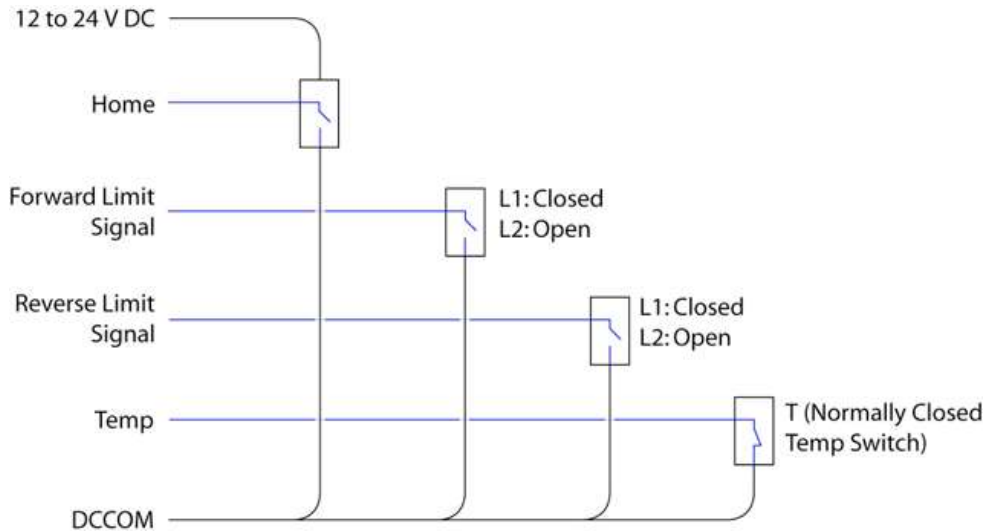

Figure 6-3: Equivalent Limit, Home, and Temp circuit schematic

The home sensor transition occurs relative to the encoder index according to the diagrams below.

	Home Transition Nominal (deg)	Home Transition Min (deg)	Home Transition Max (deg)
PDR110	13	5	20
PDR160	4	2	6
PDR210	4	2	6

Table 6-2: Home Sensor Transitions for each PDR Series

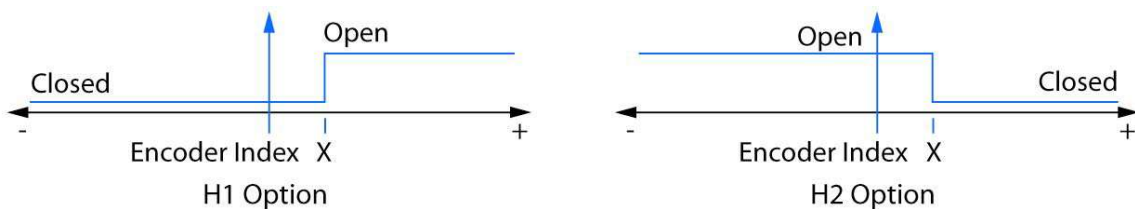

Figure 6-4: Home Transitions Chart – “X” represents Nominal Home Transition

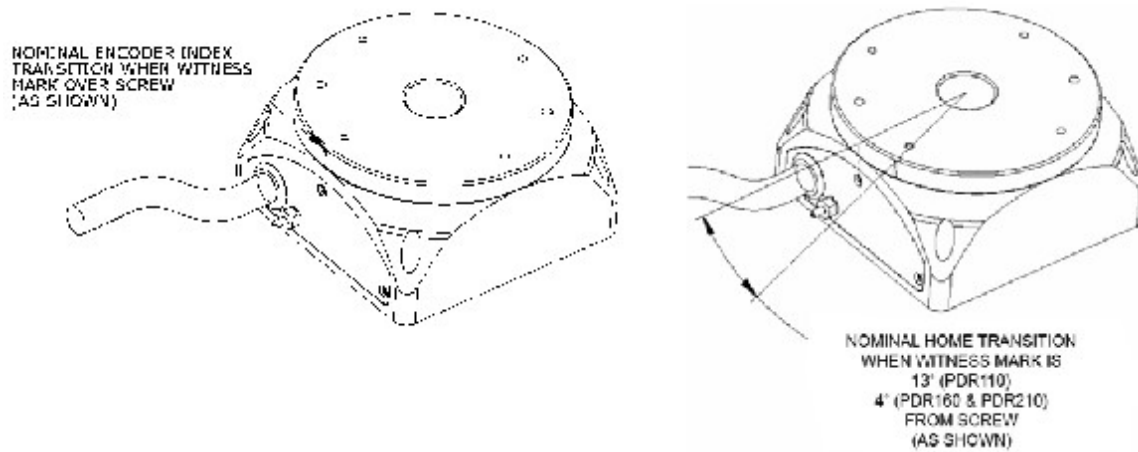

Figure 6-5: Encoder Index and Home Transitions

6.6) Recommended System Test

Before attaching a load or applying power to your stage, verify the encoder and limit switches are working properly. Move the stage by hand in the positive direction and verify the encoder count is increasing. Runaway conditions caused by miswired encoders can result in stage damage and personal injury. Move the carriage to each end of travel to ensure limit switches are working properly. When closing the position loop for the first time, set the torque limit of your controller to a low value and use conservative tuning gains. Once the control loop is working properly, payloads can be added to the stage carriage.

7) Preventive Maintenance

The PDR series rotary stage does not require periodic maintenance. The motor and encoder are non-contact devices and the bearing element is pre-packed with grease and does not need relubrication.

The stage should be kept clean and a soft cloth should be used wipe down the stage. Do not use compressed air to spray away dust since this may force dust into crevices.

8) Troubleshooting & Service

8.1) Troubleshooting Help

For further assistance contact the factory:
M-F 8AM to 5PM Pacific Time

Phone:	[541] 791-9678
Fax:	[541] 791-9410
Web:	www.primatics.com
E-mail:	service@primatics.com

8.2) Service

Should your device require factory service, contact the factory for a Return Materials Authorization (RMA). When inquiring about an RMA please have the following information available:

- Your contact information (name, phone, email, address)
- Unit Serial Number (located as shown below)
- Symptom of problem
- History of troubleshooting steps already taken



Figure 8-1: Unit Serial Number Location